

Structural Diagram

### Specification:

- 1.Low Loss IL:  $\leq 0.25\text{dB}$
- 2.Return Loss:  $\geq 65\text{dB}$
- 3.Operation Environment:  $-40\sim+85^{\circ}\text{C}$
- 4.Storage Environment:  $-40\sim+85^{\circ}\text{C}$

		<b>SHENZHEN OPTICO COMMUNICATION CO., LTD.</b>							
Model	E2000APC-E2000APC SM G657A2 Duplex 2.0/3.0mm Yellow LSZH CPR-Dca Cable						OP-2F-E20A-FP-2.0/3.0-SM- DX		
FIRST ANGLE PROJECTION 	MATERIAL	UNIT	SCALE	SIZE	SHEET	DRAWN	XUELING W	DATE	2025.04.29
	LSZH	m	/	A4	1	CHECKED	Michael Liu	DATE	2025.04.29
						APPROVED	STEVEN Zhang	DATE	2025.04.29

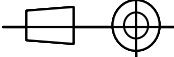
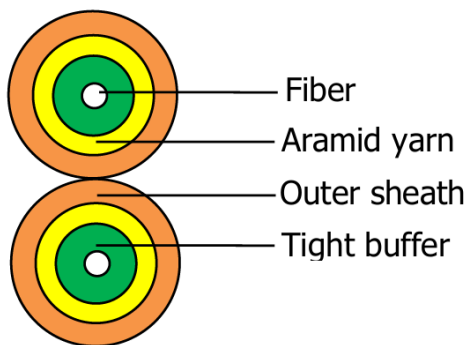
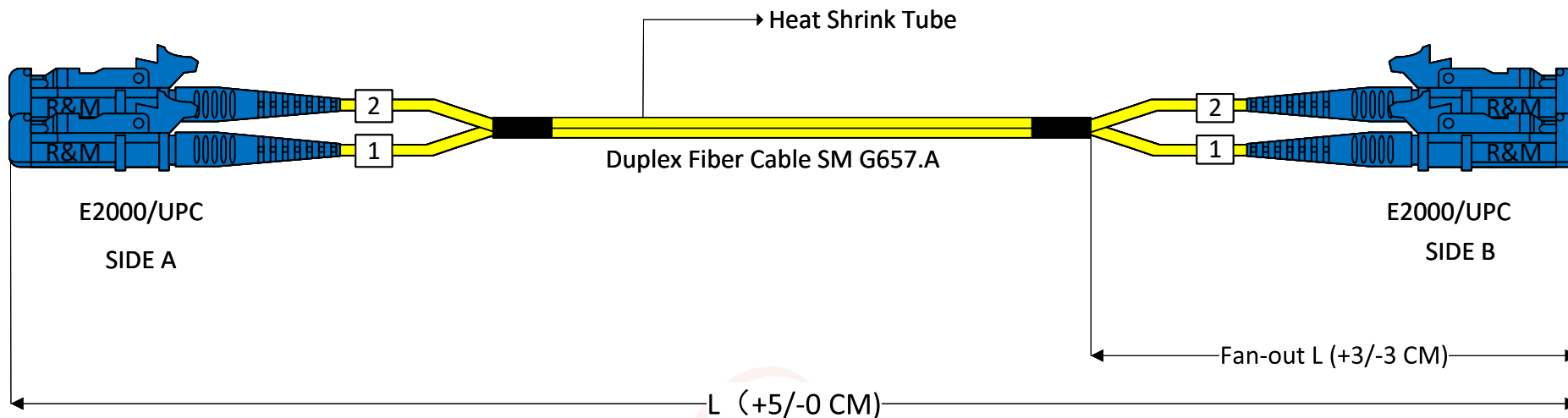

Structural Diagram

### Specification:

1. Low Loss IL:  $\leq 0.25\text{dB}$
2. Return Loss:  $\geq 55\text{dB}$
3. Operation Environment:  $-40\sim+85^{\circ}\text{C}$
4. Storage Environment:  $-40\sim+85^{\circ}\text{C}$

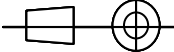
		<b>SHENZHEN OPTICO COMMUNICATION CO., LTD.</b>							
Model	E2000UPC-E2000UPC SM G657A2 Duplex 2.0/3.0mm Yellow LSZH CPR-Dca Cable						OP-2F-E20U-FP-2.0/3.0-SM- DX		
FIRST ANGLE PROJECTION 	MATERIAL	UNIT	SCALE	SIZE	SHEET	DRAWN	XUELING W	DATE	2025.04.29
	LSZH	m	/	A4	1	CHECKED	Michael Liu	DATE	2025.04.29
						APPROVED	STEVEN Zhang	DATE	2025.04.29

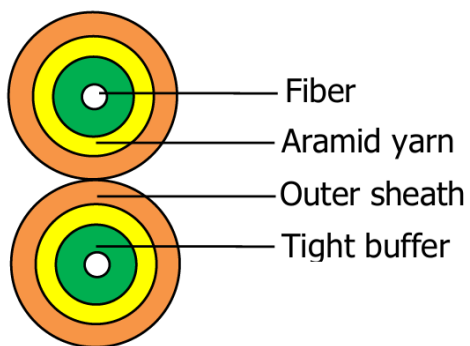
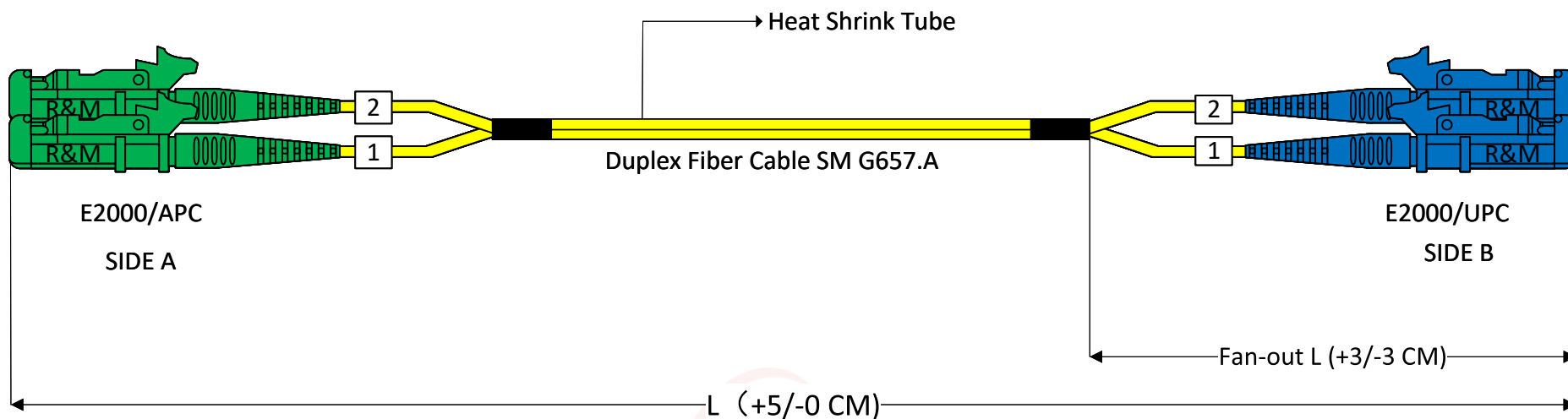

Structural Diagram

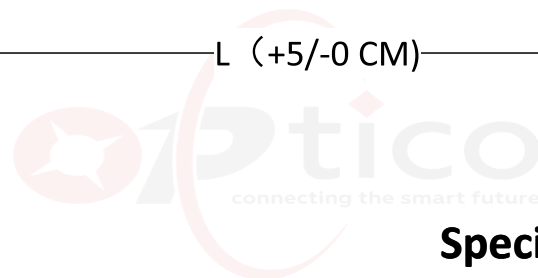

**Specification:**

- 1.Low Loss IL:  $\leq 0.25\text{dB}$
- 2.Return Loss:  $\geq 55\text{dB}$
- 3.Operation Environment:  $-40\sim+85^{\circ}\text{C}$
- 4.Storage Environment:  $-40\sim+85^{\circ}\text{C}$

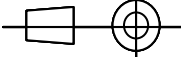
		<b>SHENZHEN OPTICO COMMUNICATION CO., LTD.</b>							
Model	E2000APC-E2000UPC SM G657A2 Duplex 2.0/3.0mm Yellow LSZH CPR-Dca Cable						OP-2F-E20U-FP-2.0/3.0-SM- DX		
FIRST ANGLE PROJECTION 	MATERIAL	UNIT	SCALE	SIZE	SHEET	DRAWN	XUELING W	DATE	2025.04.29
	LSZH	m	/	A4	1	CHECKED	Michael Liu	DATE	2025.04.29
						APPROVED	STEVEN Zhang	DATE	2025.04.29